

BYONICS

TinyTrak4 DK Adapter

Manual version 1.3

The TinyTrak4 DK adapter is a small circuit board designed to ease the connection of a display and a PS/2 Keyboard to the TinyTrak4 kit and surface mount built units. It is available as a kit, or as a built unit.

The components of the TinyTrak4 DK adapter are:

- The printed circuit board
- 1x16 0.1" header socket (to be mounted to the PCB)
- 1x16 0.1" header posts (to be mounted to the display)
- 2x5 right angle 0.1" header posts (for the ribbon cable connection) See Note below
- PS/2 PCB mount socket (for the keyboard connection)
- 10K variable resistor / potentiometer (for display contrast adjustment)
- 0.1uf capacitor
- 62 ohm resistor (sometimes included with the display)
- 6" 10 conductor ribbon cable with 2x5 IDC connectors on each end

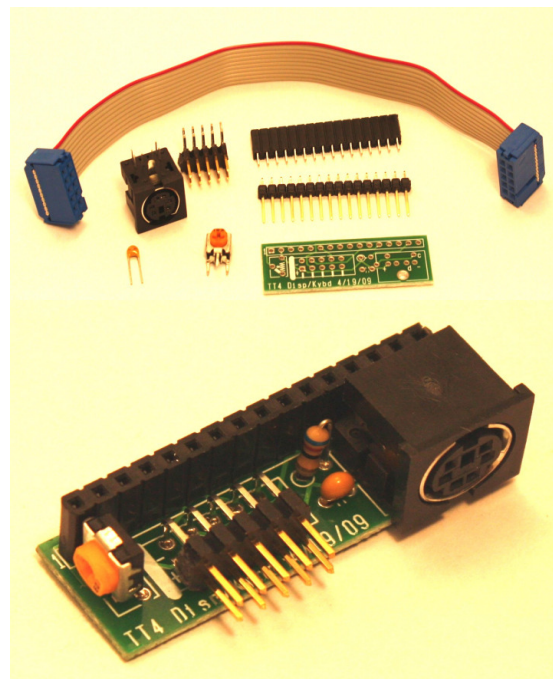

Assembly is fairly straightforward. The included image should help with component placement. All components should be added to the printed side of the PCB. The 1x16 header posts should be inserted from the underside of the display, with the shorter post through the holes, and soldered on the top side of the display.

Note: It is recommended that the ribbon cable be connected to the 2x5 right angle header posts (on the straight side) before soldering to insure the header does not sit too close to the circuit board

The ribbon cable should be connected with the red stripe nearest the variable resistor. Either side of the ribbon cable can be connected to the adapter. The other side of the ribbon cable can be connected directly to J9 on the built TinyTrak4 with surface mount parts as shown below. Note the

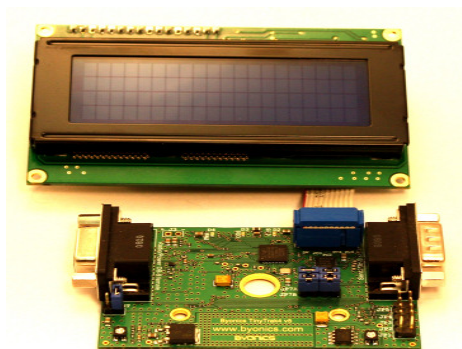

red stripe on the ribbon cable should be nearest the center of the PCB. The ribbon cable can be replaced with a longer cable if desired, up to 15 feet.

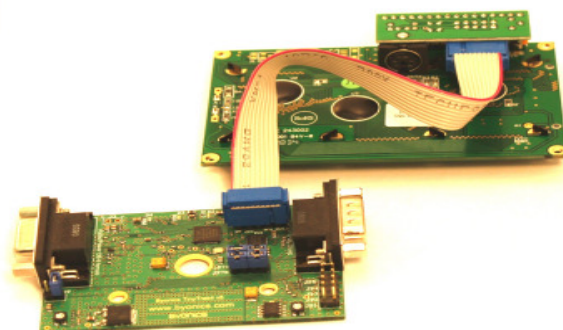

This adapter can also be used with the kit version of the TinyTrak4 with through hole components. There is not a connector for connection, so instead the ribbon cable should be soldered directly to pins on the underside of the TinyTrak4 circuit board, as shown below.

This chart shows how the connections are made.

Through hole / Kit version (PCB v6)	Surface mount / Built TT4 JP9, adapter 2x5, ribbon cable.	Function
C17 +	Pin 1 (red stripe)	+5 Volts
C17 -	Pin 2	Ground
U1 pin 22	Pin 3	Display Data4, PORTC0
U1 pin 23	Pin 4	Display Data5, PORTC1
U1 pin 24	Pin 5	Display Data6, PORTC2
U1 pin 25	Pin 6	Display Data7, PORTC3
U1 pin 26	Pin 7	Display RS, PORTC4
U1 pin 27	Pin 8	Display E, PORTC5
U1 pin 28	Pin 9	Keyboard Clock, PORTC6
U1 pin 29	Pin 10	Keyboard Data, PORTC7

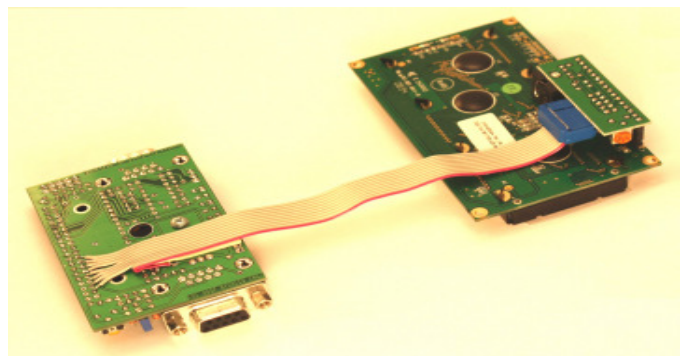
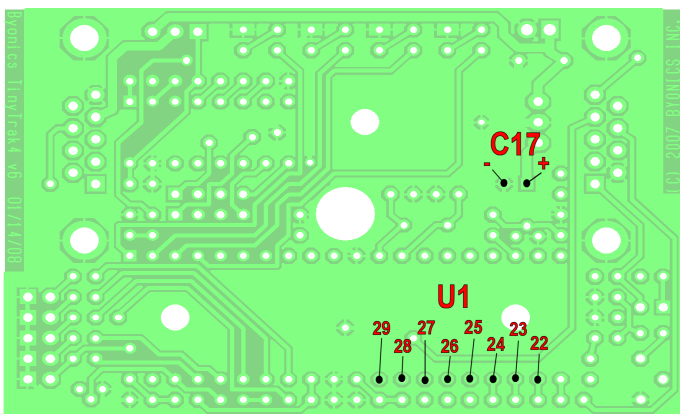
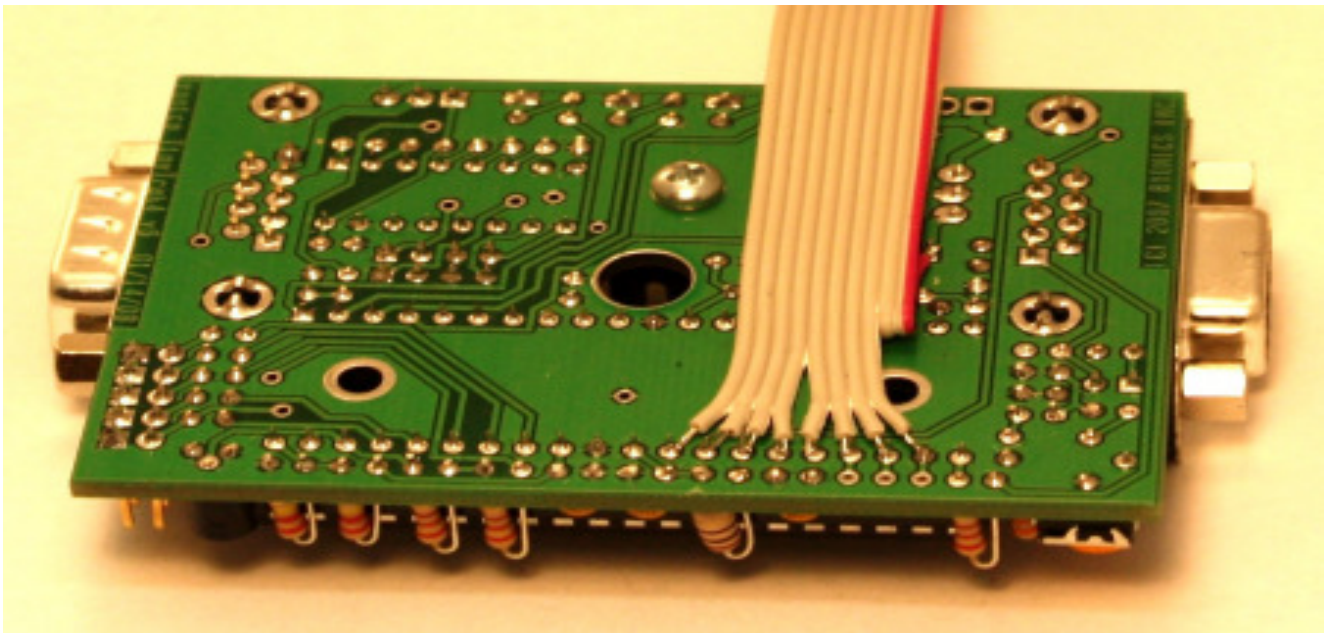

The 6 pin mini DIN jack can take any PS/2 computer keyboard, as shown below.

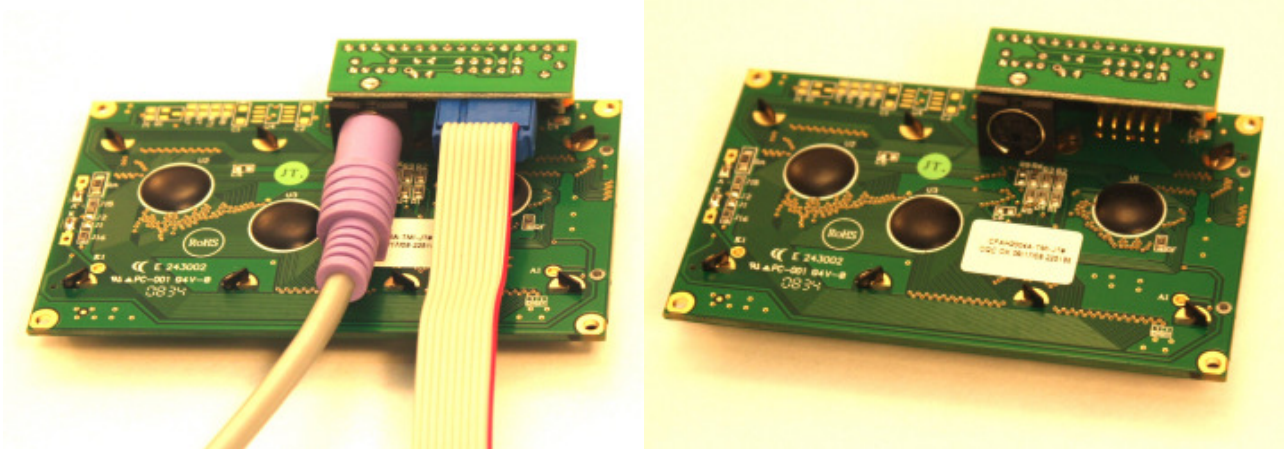

Load a firmware file into the TinyTrak4 that supports the display and keyboard, such as the Alpha firmware version 0.52 and later.

Don't be surprised if nothing appears on the screen at first. It may be the contrast pot on the adapter. Some displays, such as the one sold by Byonics, do not need a contrast control, and instead should be set to ground by rotating the pot fully clockwise.